

AL-RPL70 US
AL-REF32
AB-PL70-M/K
36-DURIS

RPL70 LED PROFILE

RPL70 US; 41 x 109 mm

So far the biggest profile from Plaster Board Line (70mm width of diffuser). The raw aluminum surface and the matching shade emphasize the quality of the product. Innovative design provides unique features such as: Premade angle modules, mounting rail for the junction box and dedicated openings for the ease of installation. Thanks to efficient heat dissipation surface, it can be safely used for high power LED strips (up to 50W/m). The profile can be equipped with reflectors made of highly polished aluminum with a light reflectance (> 95%). This solution improves the luminaire's efficiency by 10-20%. The profile has been designed so that there are no visible points of light. Depending on external conditions, we offer our clients three types of UV-resistant diffusers: matt & transparent and prismatic (UGR <19).

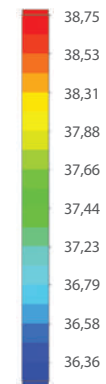
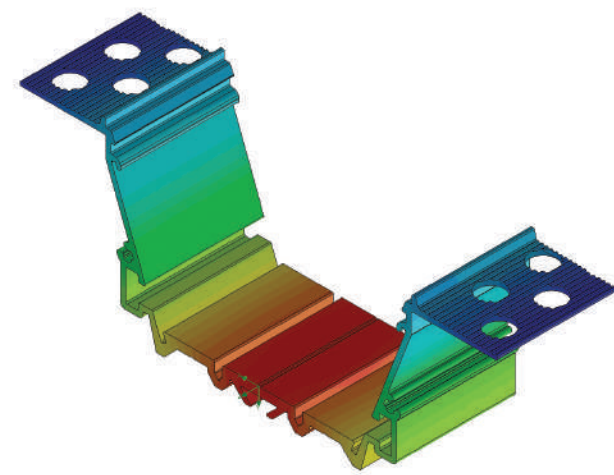
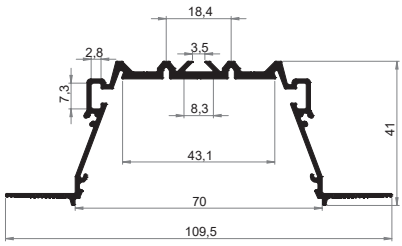

Temperature (Solid) [°C]
Ambient temperature : 25° C
Total power: 60 W/m



RPL70 US horizontal connection using 90LC-HOR



RPL70 US vertical connection using 90LC-VER

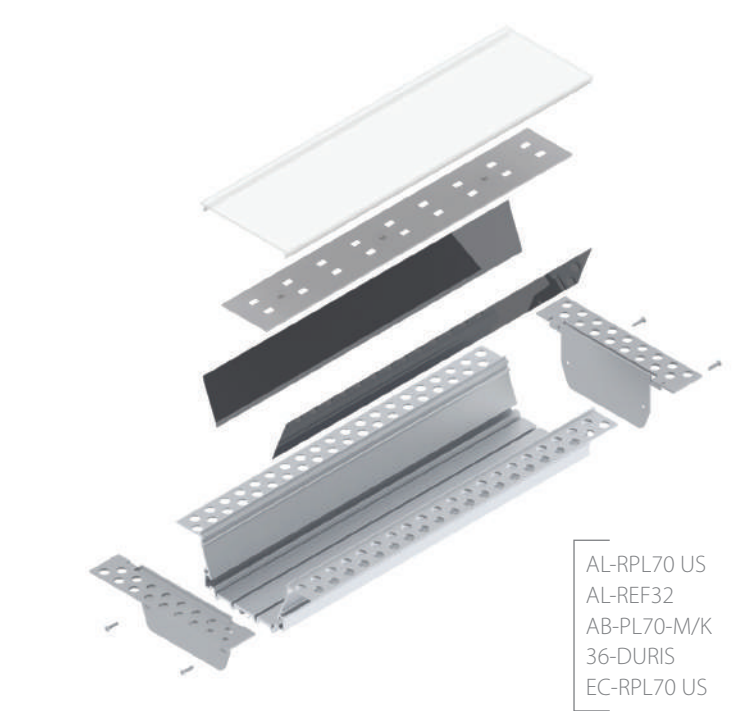

AL-RPL70 US
AL-REF32
AB-PL70-M/K
36-DURIS
EC-RPL70 US

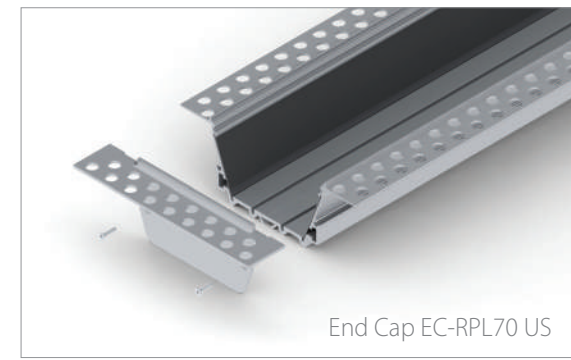

End Cap EC-RPL70 US

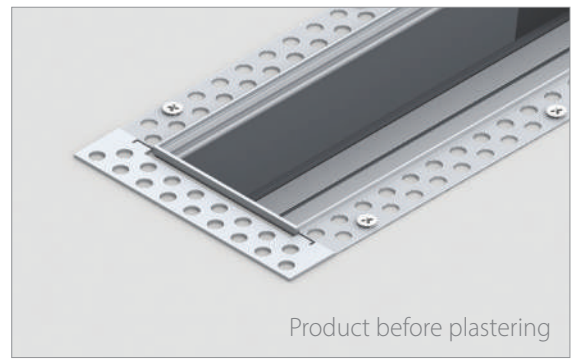

Product before plastering

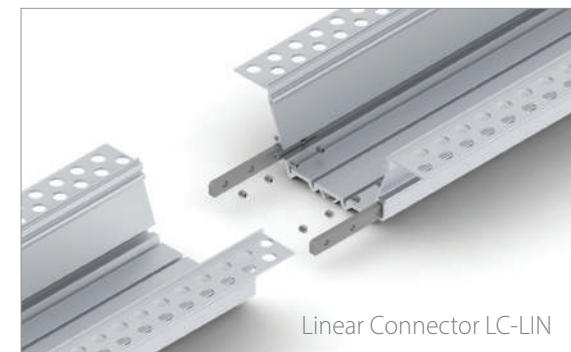

Linear Connector LC-LIN



RPL70 US with junction box

Polar Candela Distribution Plot
Using Missed Rays

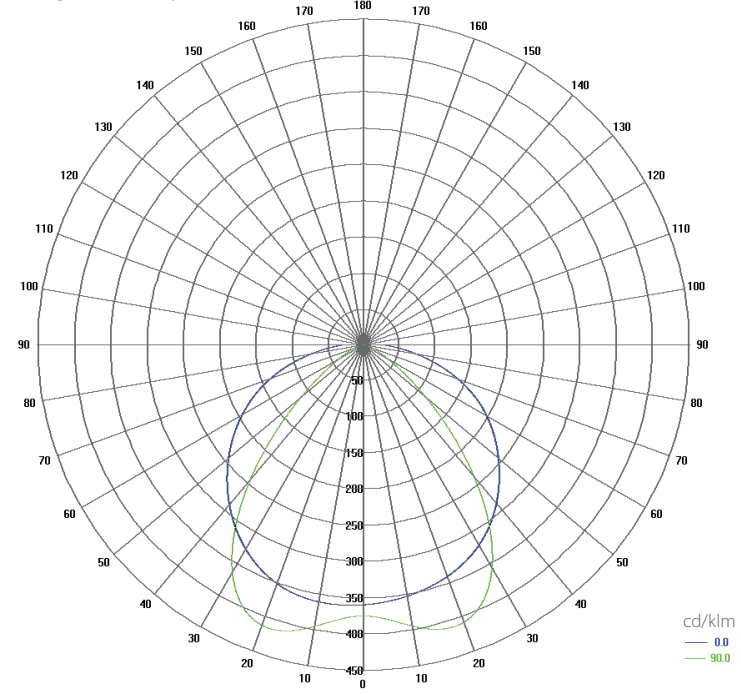

Cross section view of RPL70 US

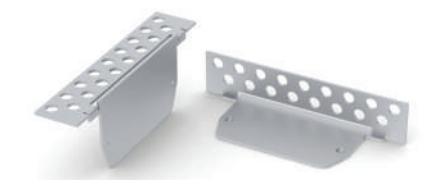

Aluminum end caps EC-RPL70 US

AL-RPL70 US
AL-REF32
AB-PL70-M/K
36-DURIS

