



A BRIGHTER FUTURE
UK LED lighting

Micro LED Bar 18.75mm Pitch

LDT /IES files

IP54

High CRI option

Dimmable

50,000 hours



Polar Diagram

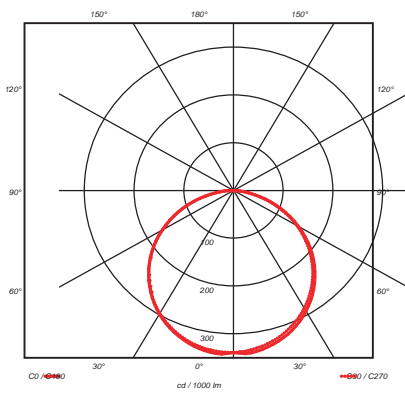

Part No.	E-30-3C2-24-150-6-SSC2
LED Pitch	18.75mm
CCT	2200k / 2400k / 2700k / 2800k / 3000k / 4000k / 5700k
Lumen CRI 85	570 / 600 / 720 / 780 / 850 / 920 / 1000
CCT	2600k / 2800k / 3000k / 4000k
Lumen CRI 92	600 / 650 / 720 / 770
Beam Angle	120°
Power Consumption (per metre)	10 Watts
Volt/DC	24
Chip Used	5050 Tri chip Seoul Semiconductor / Samsung
PCB Length (mm)	150 / 75
Straight end cap combined length (mm)	11 + 11 = 22
Flat end cap combined length (mm)	3 + 3 = 6
Maximum serial connection (mm)	4500
Tc point °C	55
Lumen/Watt	57 - 112

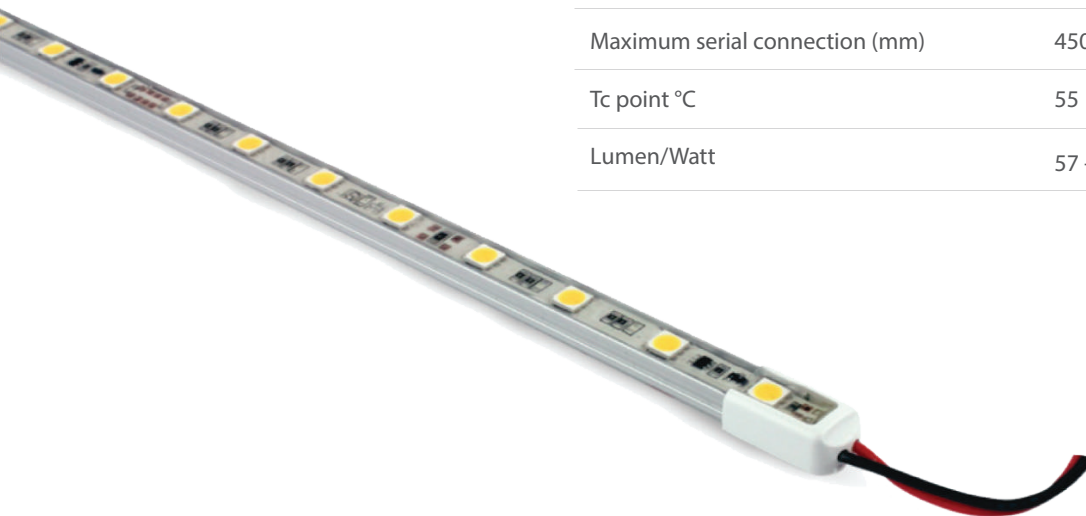

Head Office
 UK LED Lighting
 Derby Road
 Kingsbridge
 Devon
 TQ7 1JL

Tel: +44 (0)1548 853878
 Fax: +44 (0)1548 856820
 Email: enquiries@ukledlighting.com

UK LED Lighting
 Queens House
 Paragon Street
 Hull
 East Riding of Yorkshire
 HU1 3NQ

Tel: +44 (0)1482 506333
 Email: phil.irvin@ukledlighting.com

UK LED Lighting
 8 Grange Close
 Buckingham
 Buckinghamshire
 MK18 1JJ

Tel: +44 (0)1280 817284
 Email: barry.mcgowan@ukledlighting.com

Dimensions

Flat end side wired end cap

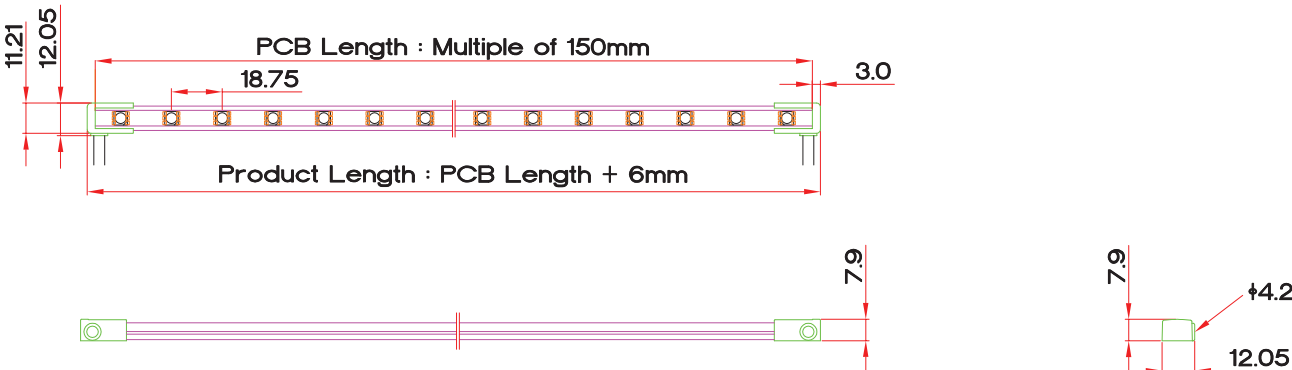

Straight end cap with fixing lug

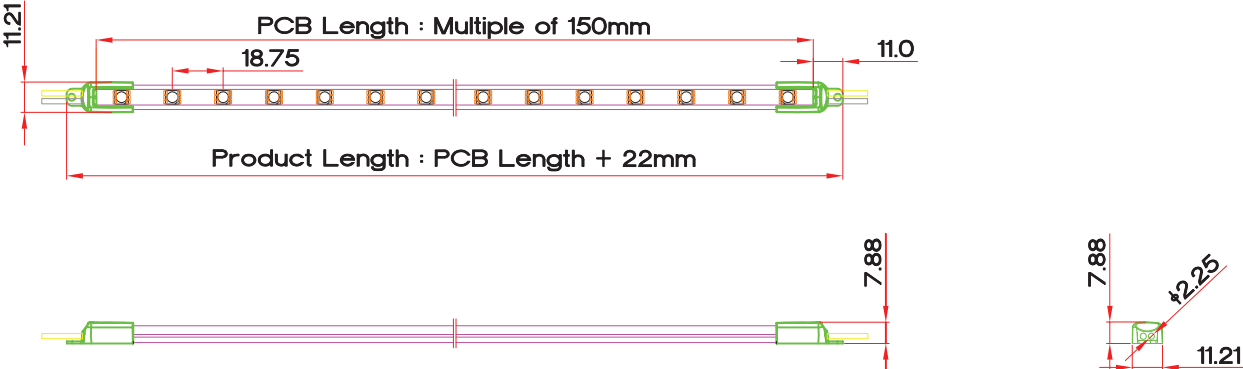

nylon fixing clip

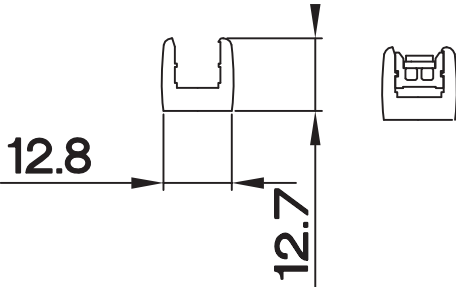

stainless steel fixing clip

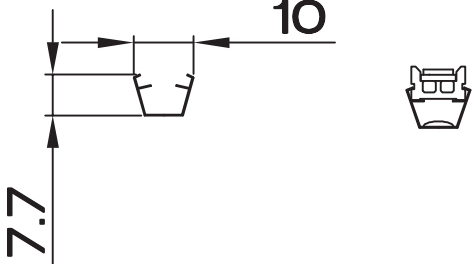

adjustable stainless fixing clip

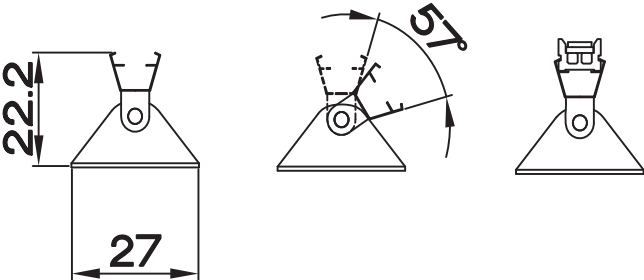

MacAdam Ellipse - 3 Step

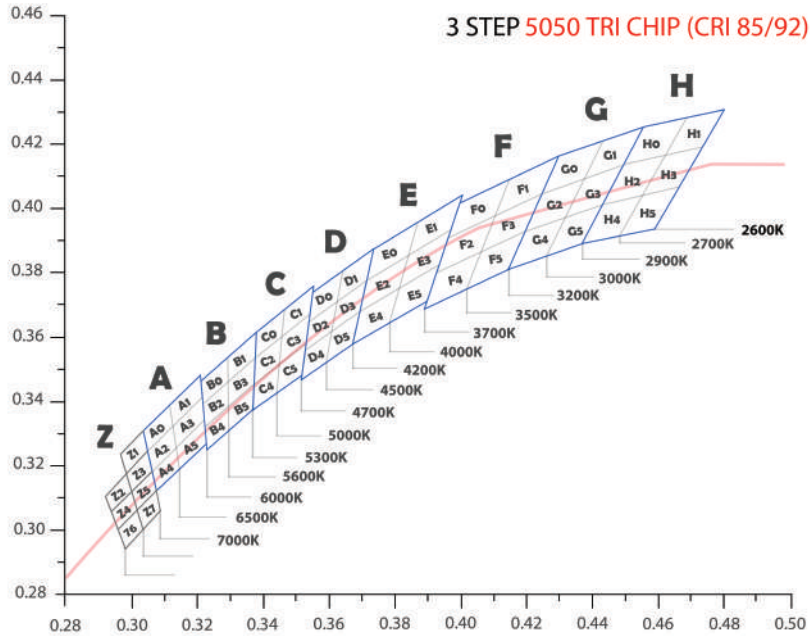

Part numbering key

